

# Typ S

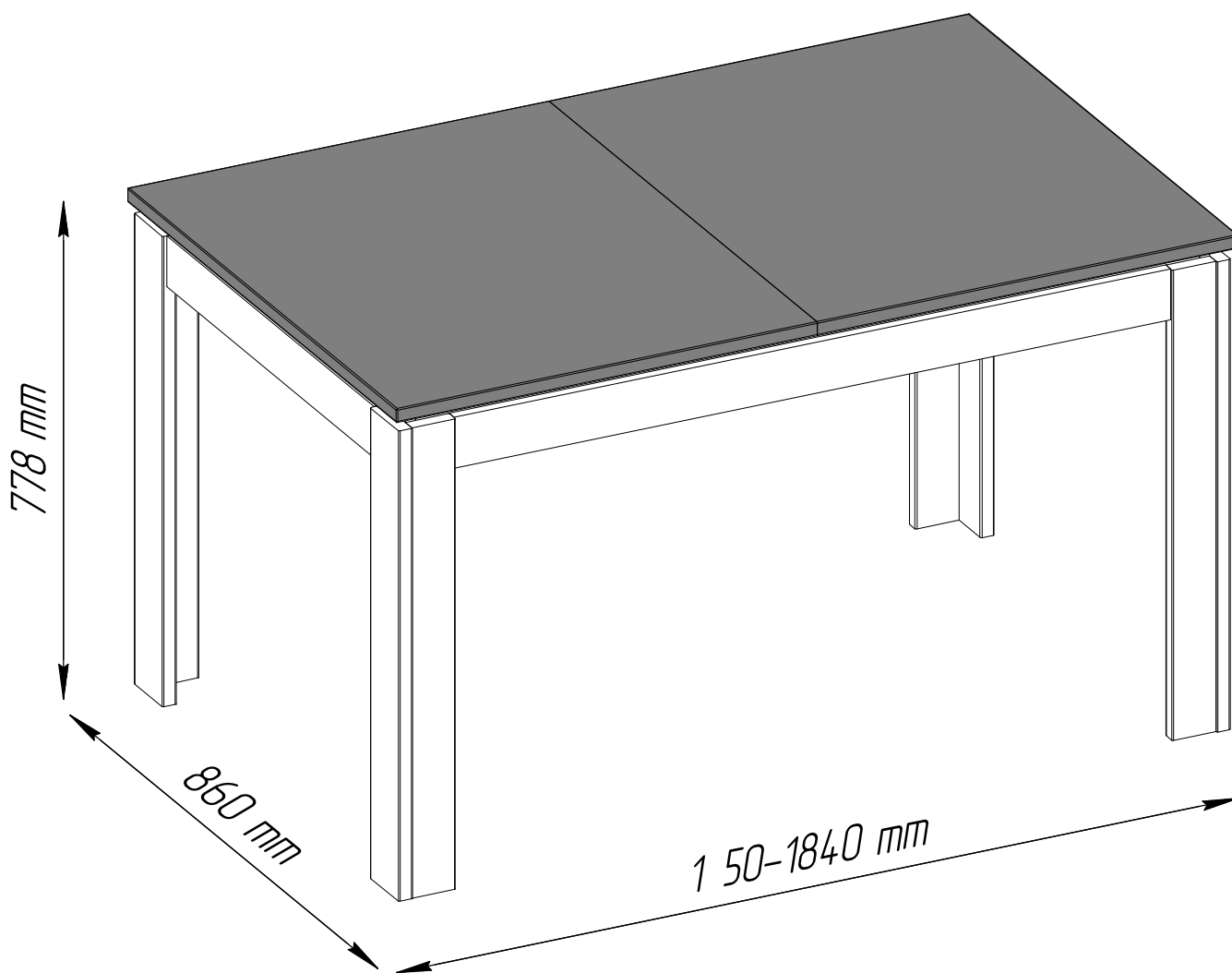

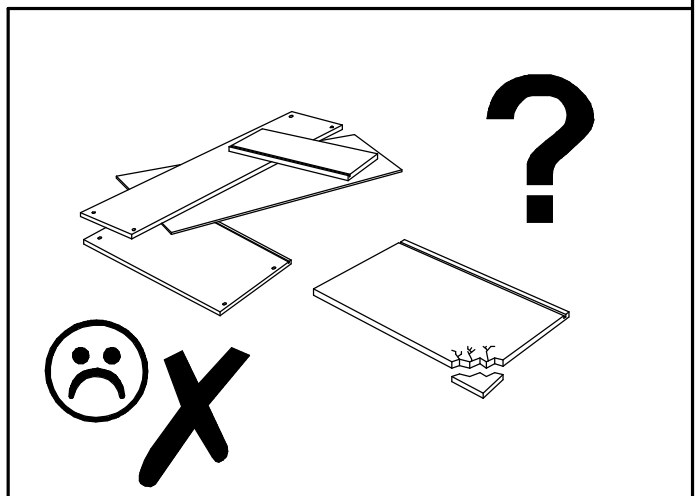

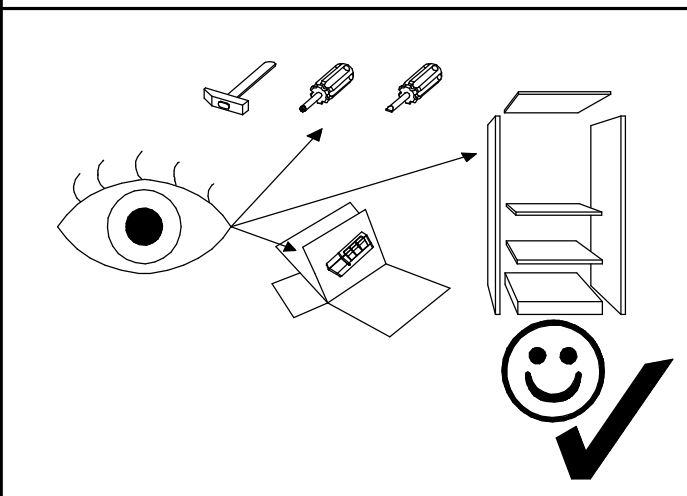
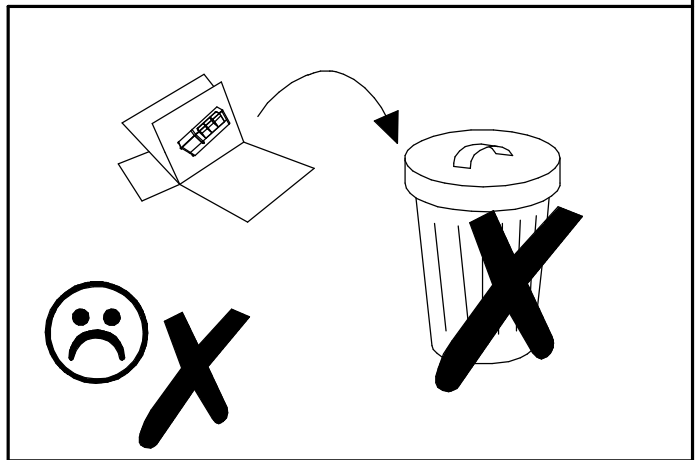
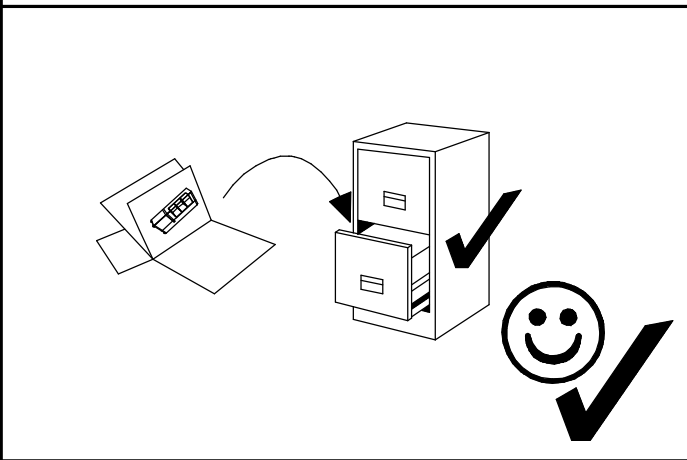
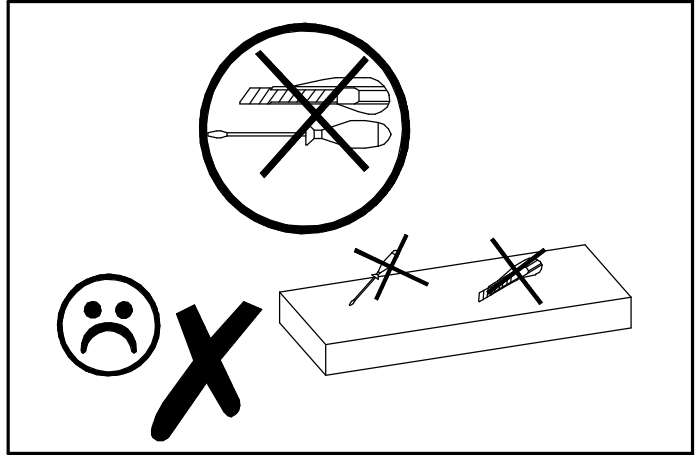
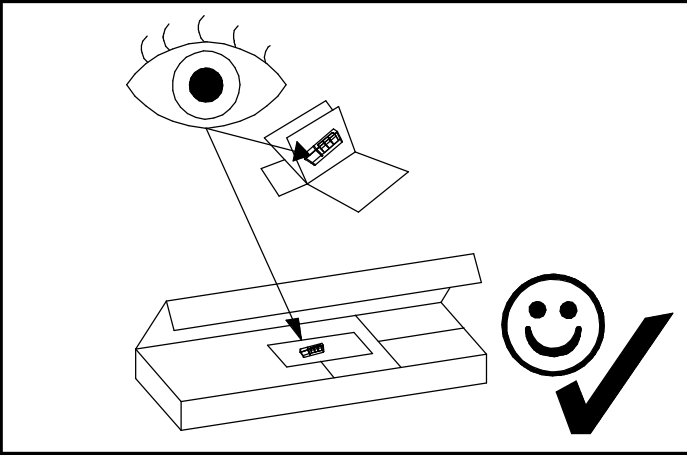
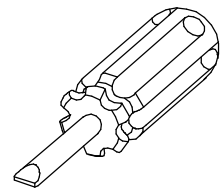
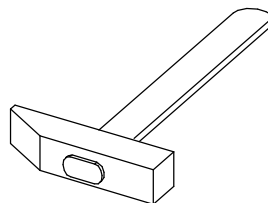
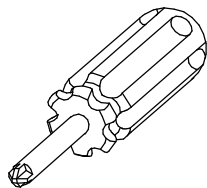
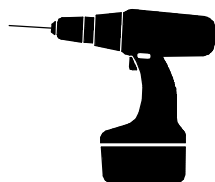
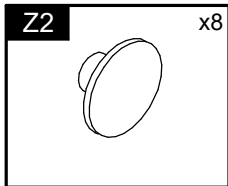
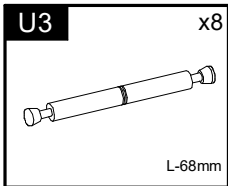
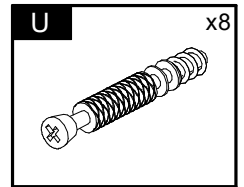
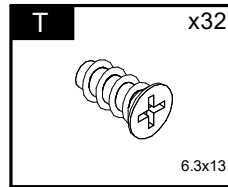
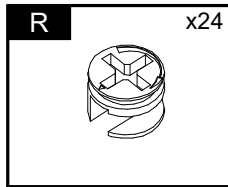
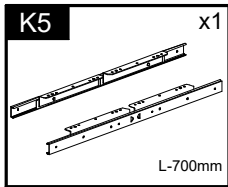
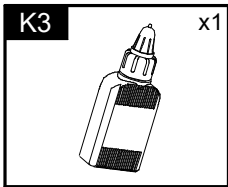
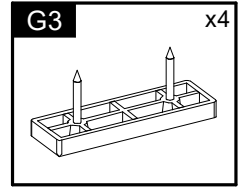
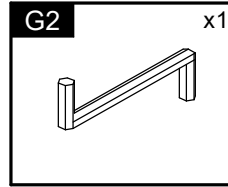
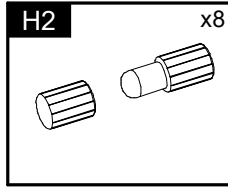
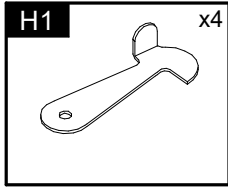
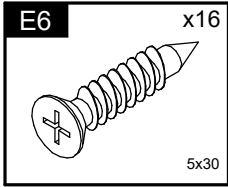
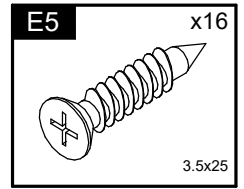
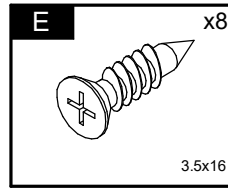
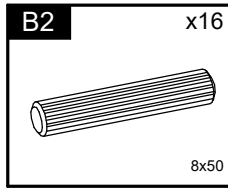
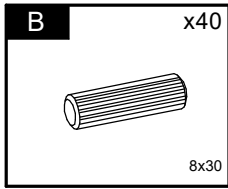
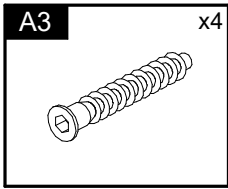
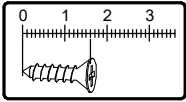
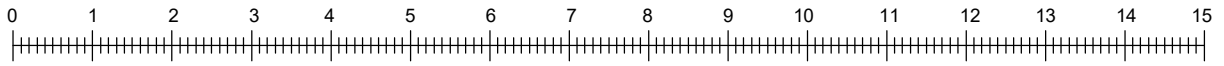

Element symbol	Measurements				Code	Paket
1	675	860	22	1	1016	1/2
2	675	860	22	1	1017	1/2
3	490	860	22	1	1018	1/2
4	740	92	22	1	1003	1/2
5	740	92	22	1	1004	1/2
6	740	70	22	1	1005	1/2
7	740	70	22	1	1006	1/2
8	740	70	22	1	1012	1/2
9	740	70	22	1	1013	1/2
10	740	92	22	1	1014	1/2

Element symbol	Measurements				Code	Paket
11	740	92	22	1	1015	1/2
12	767	92	16	1	1009	1/2
13	767	92	16	1	1010	1/2
14	799	92	16	1	1011	1/2
15	799	92	16	1	1007	1/2
16	1257	92	16	1	1001	2/2
17	1257	92	16	1	1008	2/2
18	663	80	16	2	1020	1/2
19	1149	80	16	2	1022	1/2

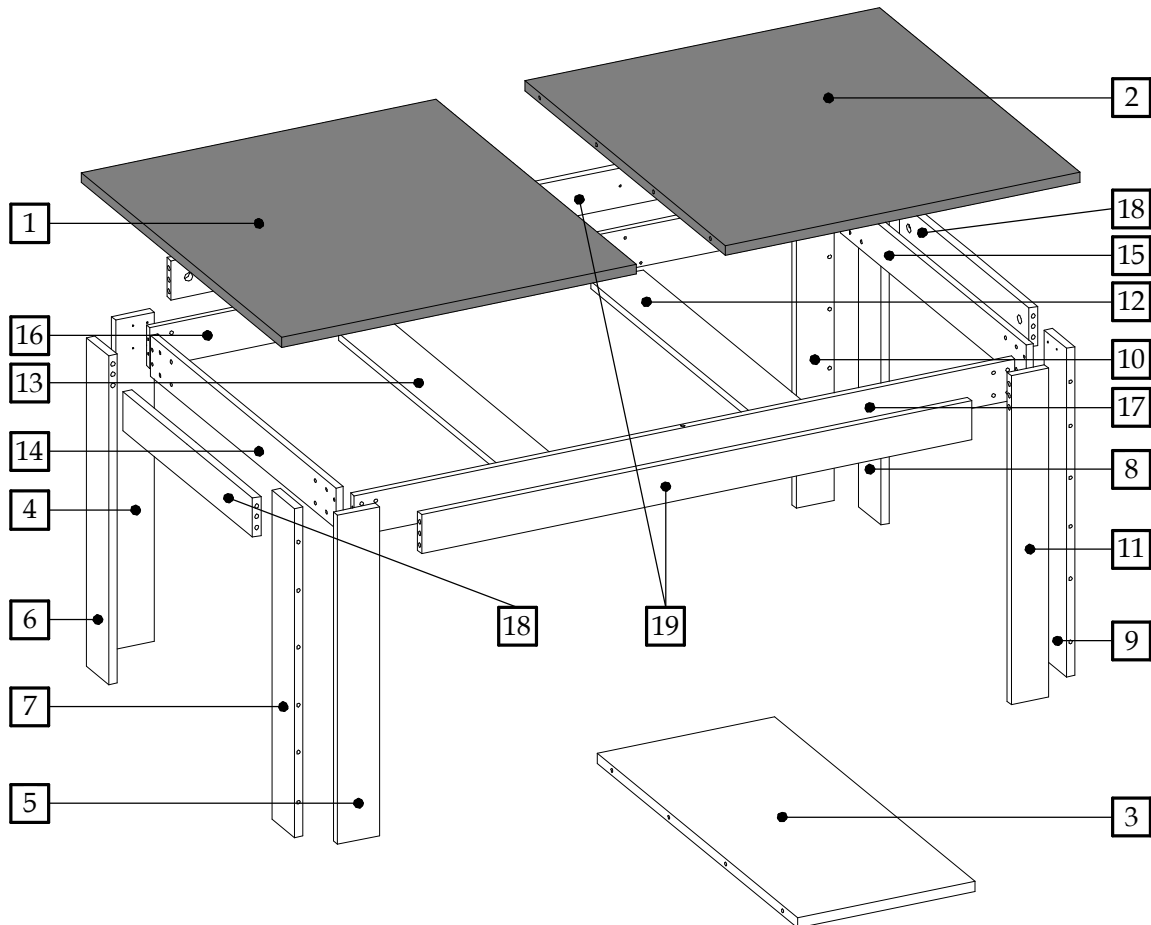

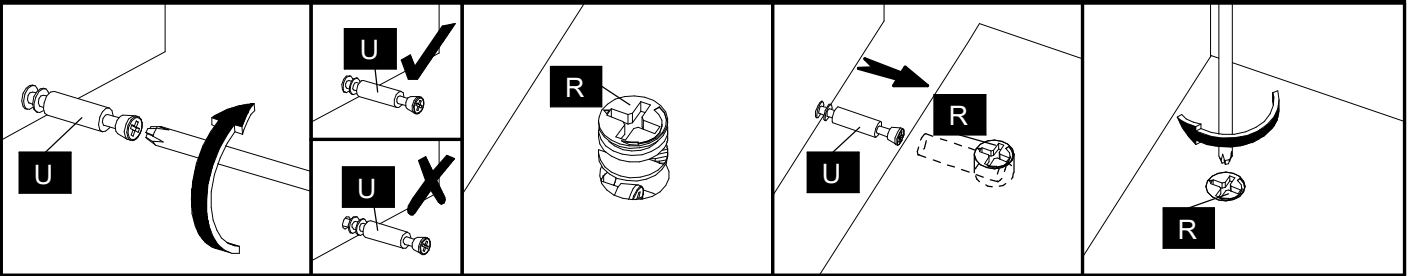

1

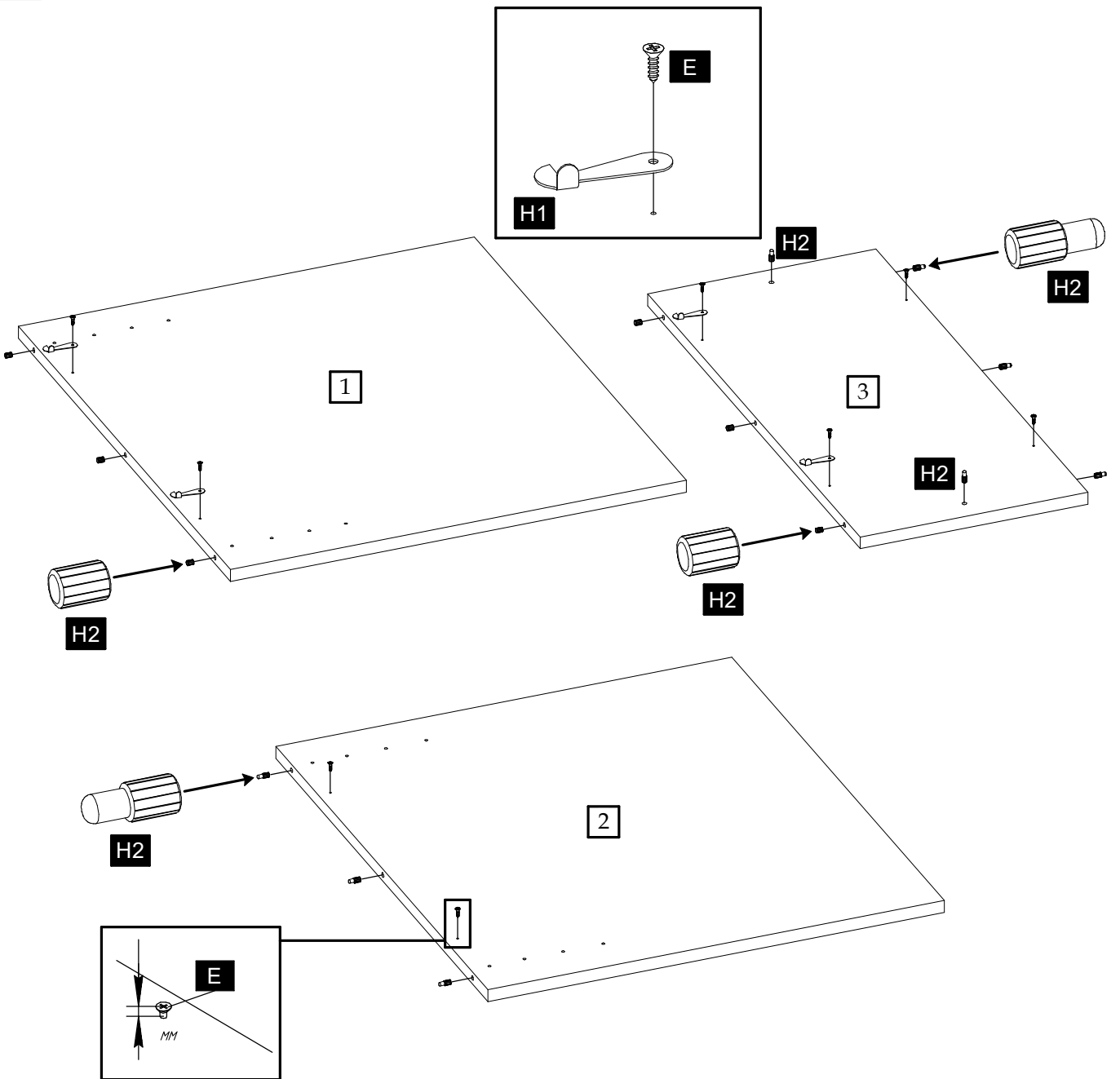

2

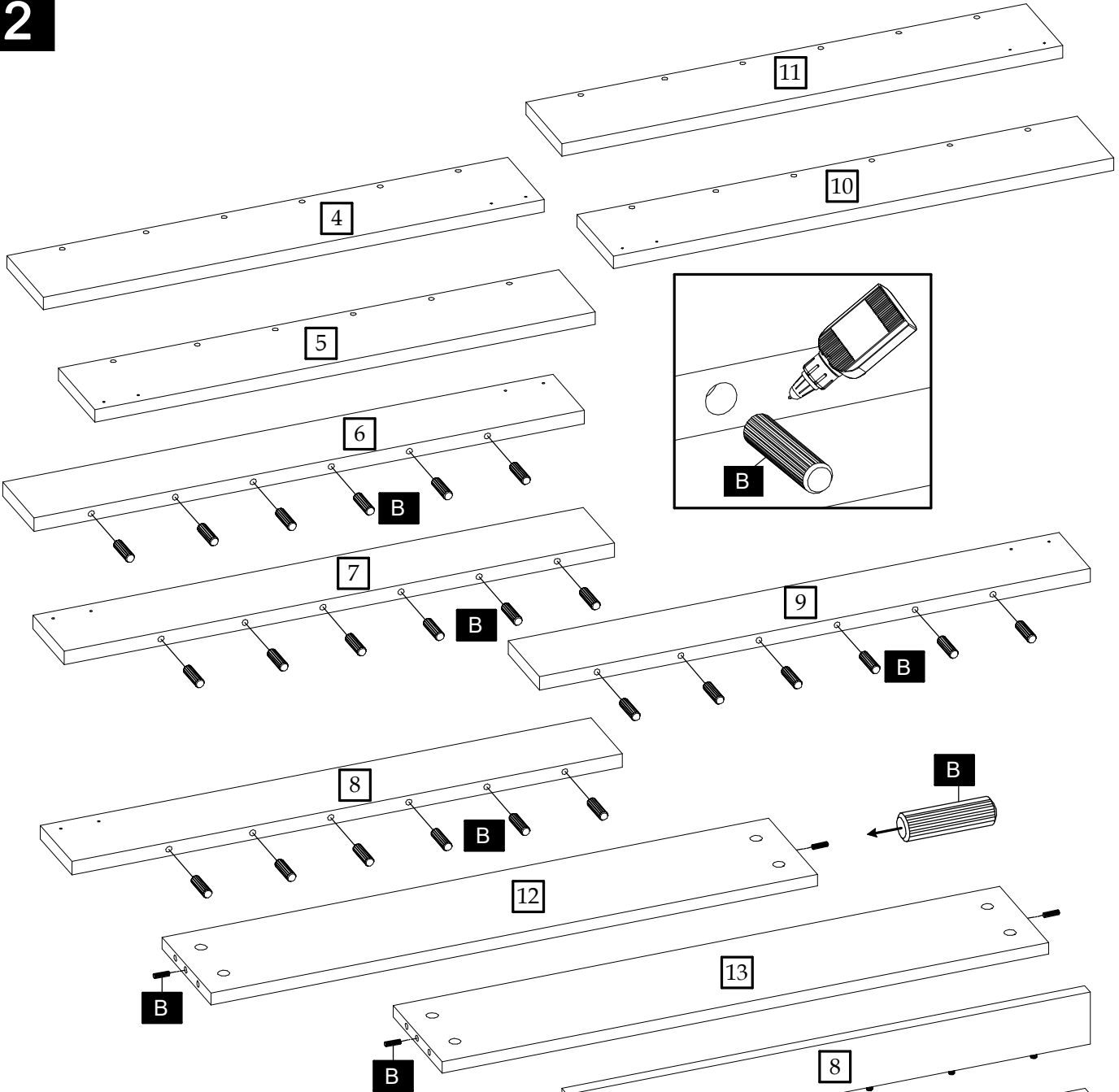

3

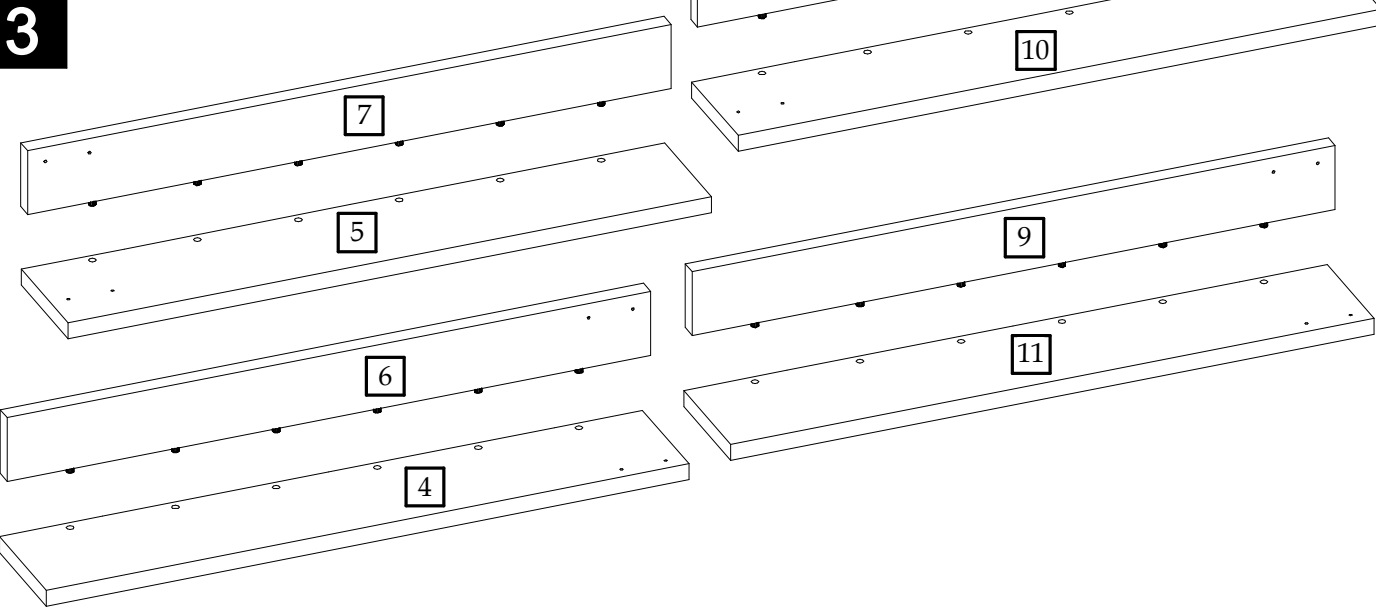

4

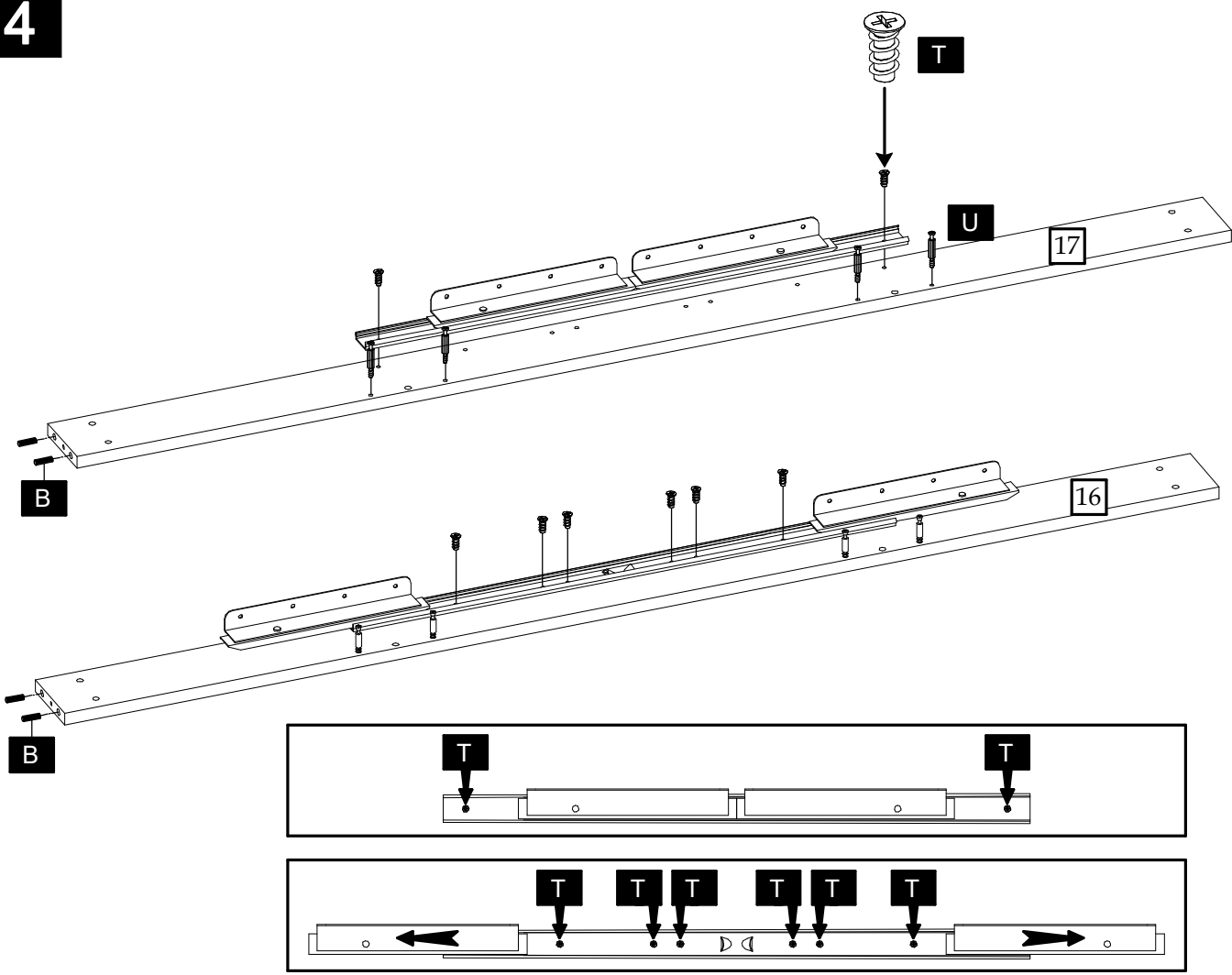

5

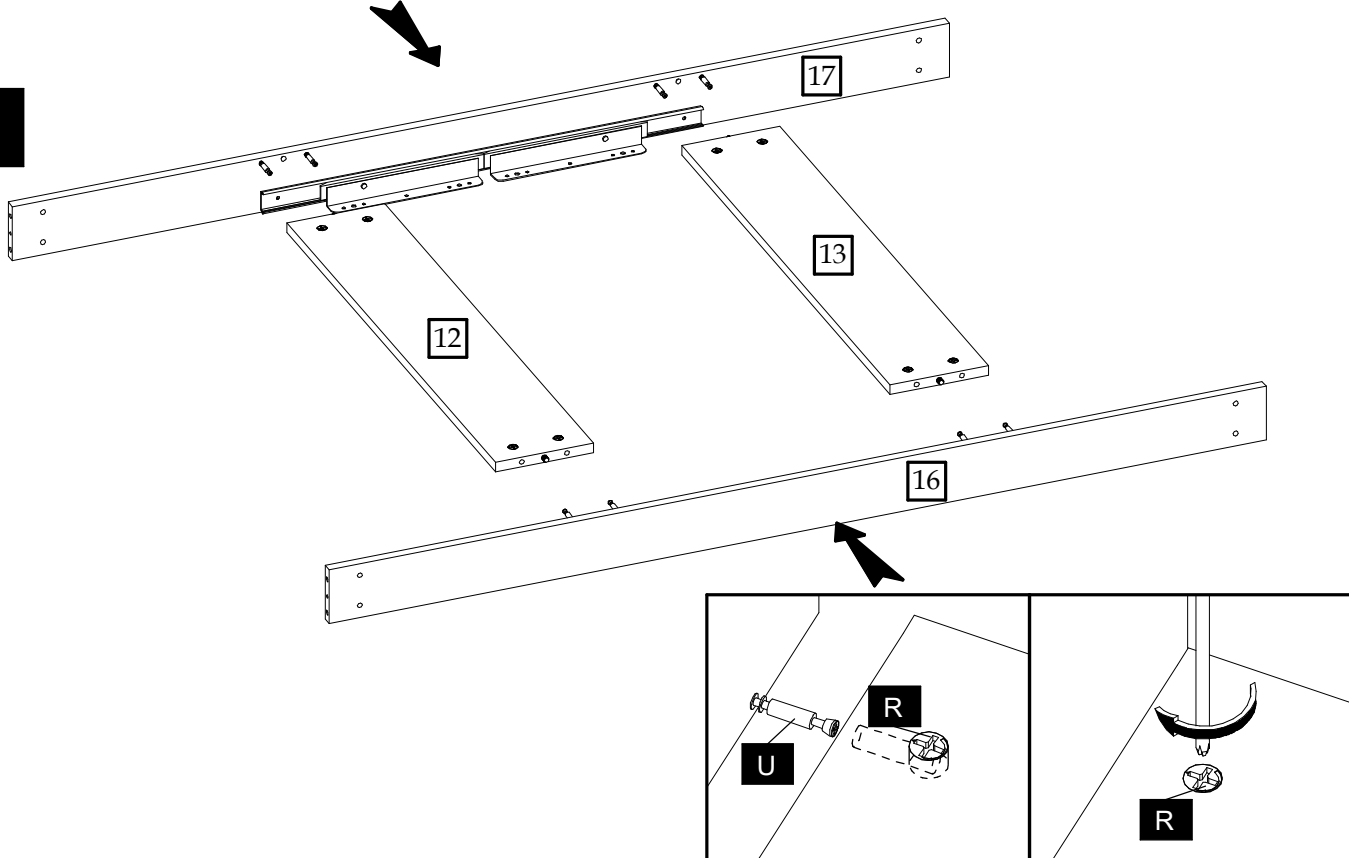

6

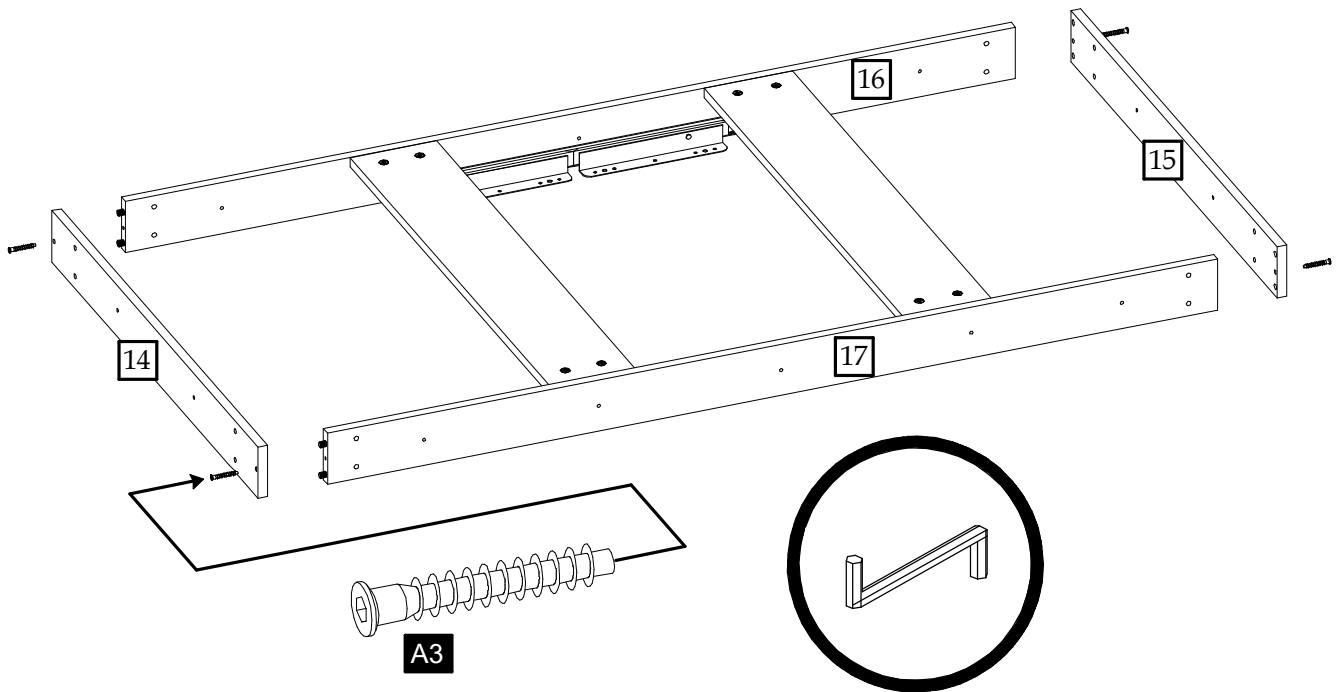

7

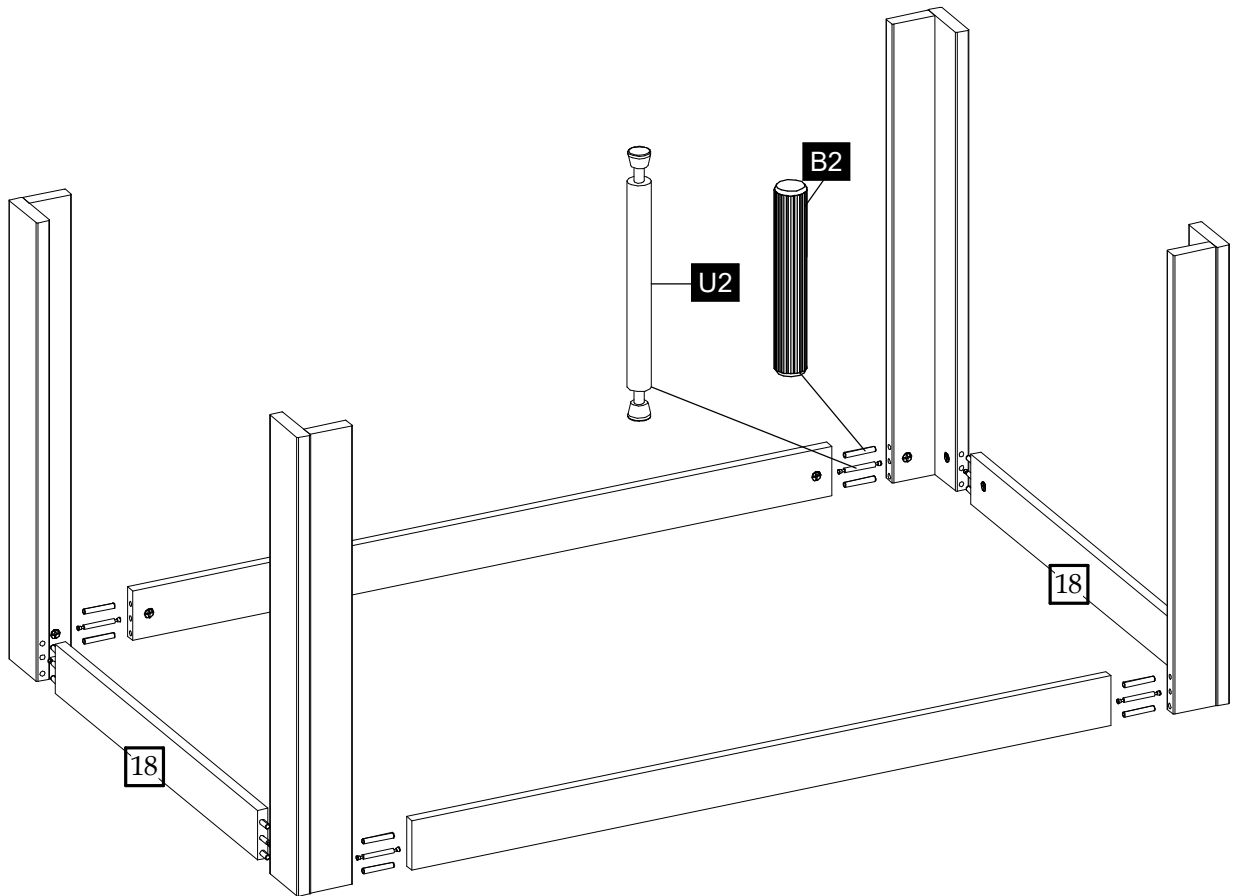

8



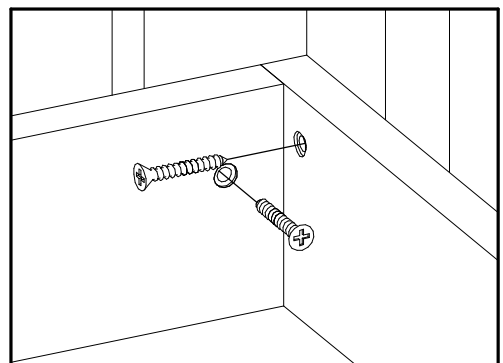
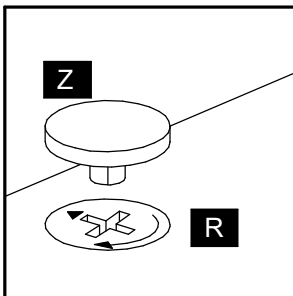
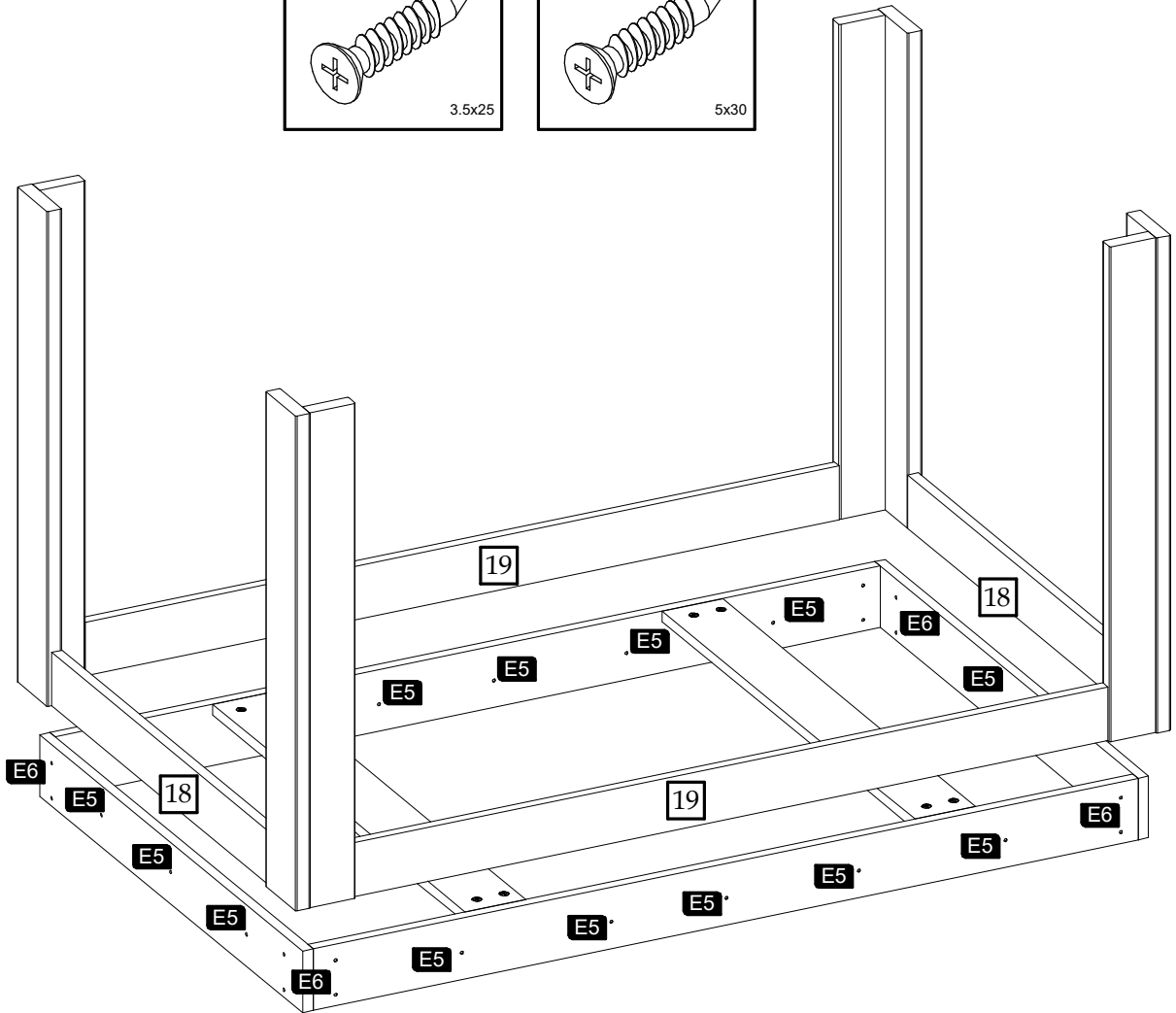
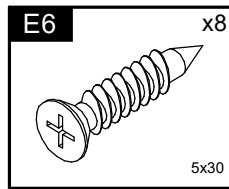
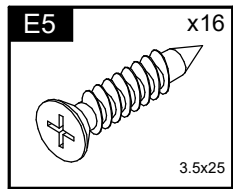
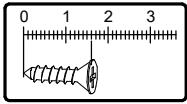
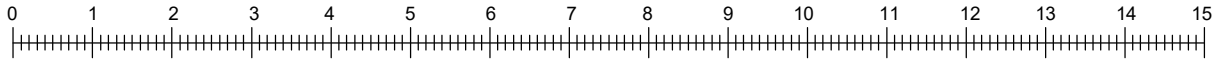

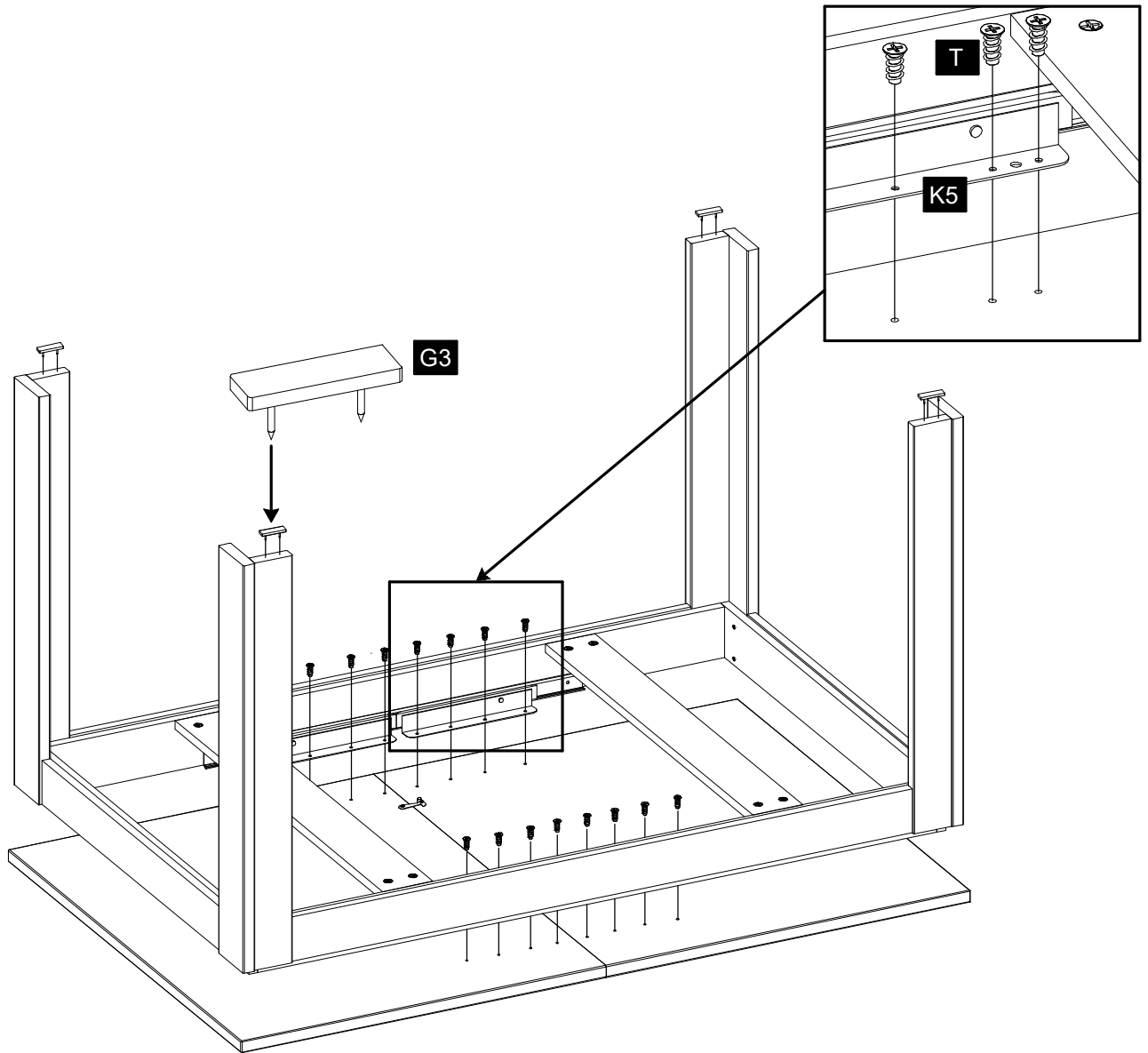

max.  
80 kg

